



P.P.U.H. „Geco” spółka z o. o.
30-134 Kraków POLAND
ul. Zarzecze 112 A
tel. 012 6369811, 6361290
fax. 012 6362002

SELF-DEPENDENT REGULATION BLOCK SERVICE'S MANUAL

G-403-P02

FOR CONTROLLING CENTRAL HEATING SYSTEM BOILERS

WITH FEEDING SCREW

Program Version 11



NOTE



In the G-403-P02 controller starting from v.11 the points of wiring from the fuel feeder and DHW pump have been switched over.

/See: fig. 2 page 15/

Please consult the information mentioned above and pay special attention when connecting the fuel feeder.

You are politely requested for the familiarization with the manual prior to making the connection and activating any of our machines. Should you have any doubts, please do not hesitate to contact our firm between 8 a.m. and 16 p.m..

Note:

The most recent update release date is provided at the bottom of each following page. Please, always use the most recent version of the manual, which can be obtained by mail free of charge after the previous order.

Table of contents

1. GENERAL CHARACTERISTICS	3
2. TECHNICAL DATA	3
3. WIRING SYSTEM AND RULES OF CONNECTION	4
4. SBR G-403-P02 OPERATION AND ADJUSTMENT METHODS	4
4.1. TEMPERATURE MEASUREMENT	4
4.2. CONTROLLER INTERLOCK THROUGH THE ROOM THERMOSTAT	4
4.3. EXCEEDING THE ALLOWABLE TEMPERATURE OF THE FUEL IN THE FEEDING SCREW	5
4.4. POWER FAILURE	5
5. G-403-P02 HANDLING.....	6
5.1. STARTING THE UNIT	6
5.2. MANUAL CONTROL	6
5.3. AUTOMATIC OPERATION	7
5.4. SUSTAINING MODE OPERATION	8
5.5. ALARM MODES	8
6. USER PARAMETERS CONFIGURATION	9
6.1. THE PRESET TEMPERATURE OF THE BOILER OUTLET WATER	9
6.2. TIME OF FEEDING THE COAL TO THE BOILER (U1)	9
6.3. TIME OF STOPPING THE FEEDING SCREW (U2)	10
6.4. SUSTAINING TIME (U3)	10
6.5. DELAY IN FAN DEACTIVATION UNDER SUSTAINING MODE (U4).....	10
7. CONFIGURATION OF THE SERVICE PARAMETERS	10
8. MIXING PUMP HANDLING.....	12
9. UTILITY HOT WATER VESSEL HANDLING.....	13
9.1. ASSEMBLY AND CONNECTION.....	13
9.2. CONFIGURATION OF THE PARAMETERS	14
10. ROOM PANEL	14
11. METHOD OF CONNECTING THE EQUIPMENT TO THE G-403-P02 CONTROLLER	15
12. TROUBLESHOOTING GUIDE	16

1. GENERAL CHARACTERISTICS

The self-dependent controller, hereafter called G-403-P02, is a convenient, modern and easy-to-use equipment. It has been made in microprocessor based techniques, with the application of the automatic surface assembly.

Depending on the installation method, the two-part casing provides the possibility of installing the control panel operating under safe voltage practically everywhere, without the necessity of running power supply cables far away from the equipment controlled.

The G-403-P02 controller has been equipped with:

- temperature sensors
 1. For measuring the temperature of water leaving the boiler;
 2. For measuring the temperature of fuel feed - (note: this sensor may be deactivated);
 3. For measuring the temperature of water in the utility hot water vessel (option)
- two digital inputs:
 1. To connect the thermostat which may force the controller to change for temperature marinating status, with the controlled water circulation pump;
 2. To connect the feeding screw cotter pins breaking sensor.

The controller is equipped with 4 outputs allowing the direct connection of equipment operating under the voltage of 230 V, such as fan, fuel feeding unit, central heating system and utility hot water circulating pumps.

If the unit is to act as the central heating system boiler controller, the G-403-P02 stabilizes the temperature of water and controls the process of fuel combustion in the boiler, preventing damping a fire. The regulation parameters may be adjusted to current conditions of operation and kinds of the boiler. The boiler has been equipped with the system of protection from the power failure or several kinds of interference.

The controller does not require any maintenance, and the keyboard has been made from the special kind of a film resistant to high-level temperatures and the majority of chemicals. The keyboard, however, must not be cleaned with sharp edge objects. Instead, a humid cloth should be used for cleaning the front panel.

In summertime, the controller should be kept connected to the power supply system, however, it should be disconnected from the power for the period of storms.

2. TECHNICAL DATA

Operating voltage	—	230V +10% -15%
Temperature	—	+5 degrees Celsius - + 40 degrees Celsius
Relative humidity	—	od 20% do 80%
Protection degree	—	IP65 on the control panel front

↙ NOTE!!!

The label can be found on each casing, meaning:

- serial number;
- description of inputs, including their load capacity;
- SBR type.

Important:

The total current consumed by the equipment must not exceed 10A !!!

3. WIRING SYSTEM AND RULES OF CONNECTION

1. The boiler house should be equipped with the 230V/50Hz wiring system, in accordance with applicable regulations.
2. Irrespective of the wiring system kind, the plug-in sockets should be equipped with the protective terminal. **The application of the socket without the protective terminal connected is a shock hazard!**
3. The controller should be connected to the separate power supply line, protected by means of the 2-4A rapid fuse and the residual current circuit breaker, with activation current 20 mA maximum. **The connection of any other equipment to this line is not allowed!**
4. The clamp conductor joints used are certified for continuous load of 16 A. As the fine thread and special metal sheets preventing conductors cutting have been applied, a perfect contact is achieved with slight screwing of the conductor. Applying larger force may lead to breaking the thread.
5. The power supply cables must be firmly attached along their entire length and should not catch the water coat or the outlet to the chimney.
6. Following the connection of the unit to the power supply, the unit may be energized irrespective of switching on or off by means of the  pushbutton, *therefore any repairs may be performed only when the voltage is disconnected from the fuse!*

4. SBR G-403-P02 OPERATION AND ADJUSTMENT METHODS

4.1. Temperature measurement

The controller measures the temperature within the range of 0 degree Centigrade to 100 degree Centigrade. The temperature is displayed with the delay of one second. Where the malfunction occurs to the temperature sensor, or temperature value is found beyond the above-mentioned range and the equipment is not found in the mode of 60 second-waiting for power supply voltage stabilization following power failure, the controller reports the malfunction to the sensor. This causes both the deactivation of all activated equipment, i.e. fan, feeding screw and pump, and switching to the manual operation mode, the following symbols being then displayed:

AL1 symbol, if the flow water temperature sensor has got broken,

AL2 symbol, if the feeding screw sensor has got broken,

AL3 symbol, if the malfunction has occurred to the boiler inlet water temperature sensor or the feeding screw coupling cotter pin has got broken.

The occurrence of the temperature exactly equal to 100 degrees Celsius will cause the display to show 00°.

4.2. Controller interlock through the room thermostat

If the external room thermostat is connected to the G-403-P02 unit (see figure 2), which will be activated, i.e. will cause the output terminals to join, when the temperature preset for the heated rooms is exceeded, the unit in question will enter the interlock status.

When the room panel of our manufacture is connected to the controller, the digital inputs of the thermostat will remain inactive.

This will cause the following changes to the operation of the unit, notably:

- in the sustaining mode, the controller will cause the central heating system pump to be deactivated while the display will read “blo”;
- in the automatic operation mode, the controller will enter the sustaining mode, display the “blo” text and deactivate the central heating system pump after four minutes;
- upon the expiry of the sustaining time, the controller will activate the feeding screw and fan for the period of time predefined by the manufacturer (servicing parameter c2), in spite of the thermostat operation. The fan will operate five seconds longer than the feeding screw so that the added coal may get fired up well;
- the central heating pump operation will be dependent on the value of the c5 servicing parameter;
- the thermostat interlock will not cause the controller to abandon the controller programming mode in the automatic or sustaining mode operation;
- during the interlock, the controller will activate the central heating system pump operate for the period of 30 seconds, at the time intervals preset by the manufacturer (c5 servicing parameter) so that the water in the system may circulate.
If the value of the c5 parameter is equal to 0, the pump will not be activated;
- in any other cases, the interlock is ignored.

4.3. Exceeding the allowable temperature of the fuel in the feeding screw

The controller has been equipped with the sensor reporting that the allowable temperature of fuel in the feeding screw has been exceeded. The controller operates owing to the measurement of the feeding screw pipe temperature. If the temperature in question reaches the level of 98 degrees Centigrade, the controller reports the AL6 alarm, deactivating the fan and activating the continuous operation of the feeding screw for the period of 10 minutes so that the burning fuel may be removed from the feeder and the furnace may be put down.

Note:

The sensor of fuel ignition in the feeding screw may be deactivated if necessary (servicing parameter c1).

Whenever the c1 servicing diameter is equal to 1, if the sensor in question is missing or has become damaged, the controller will act as if the ignition of the fuel in the feeding screw has occurred and will control the feeding screw so that the “burning fuel” be removed from the feeding screw and the furnace put down. This is due to the safety reasons.

When the manual operation mode is activated, the feeding screw temperature is not checked, therefore the malfunction to the feeding screw temperature sensor launches the AL2 alarms.

If the fuel ignition sensor is not used in the boiler, the sensor may be deactivated through setting the c1 servicing parameter value to 0.

4.4. Power failure

Following power failure, the controller will start operations depending on its status prior to the occurrence of the power failure. The controller will wait for the period of one minute so that the electric grid can stabilize, after which the operation with the previously programmed values of parameters will be resumed.

During the standby mode, the display shows the time remaining to the standby mode end, as well as the denotation of the mode in which the controller operated prior to the power failure:

- blinking A letter means the automatic operation mode;
- P letter means sustaining mode;
- r letter means the manual operation mode.

Also the corresponding controls of automatic operation or sustaining mode will blink together with the letters. If the controller was under the manual operation mode, it will resume operating in this status with deactivated equipment, and if the controller was under the automatic operation mode, it will also resume the automatic operation.

If the controller was in the sustaining mode, the sustaining mode will be resumed after which the feeding screw and the fan will be activated for the limited period of time so as to prevent the furnace from putting down (c2 servicing parameter).

5. G-403-P02 HANDLING

5.1. Starting the unit

1. Connect the unit to the power supply network (insert the plug to the plug-in socket).

The display will show four horizontal dashes. All functions, in particular, the equipment controlling the boiler operation, i.e. pump, fan and feeding screw, are deactivated.

The unit will ignore pressing all pushbuttons except for the  pushbutton.

2. Turn the controller on by pressing the  pushbutton.

When this pushbutton is pressed, the controller enters the status of manual controlling of the central heating system boiler and reads the most recent user-defined settings of the boiler operation parameters (see item 6).

5.2. Manual control

Following pressing the  pushbutton, the controller enters the manual mode of central heating system boiler control. All equipment connected to the controller is deactivated, and the display shows the central heating system boiler water temperature, measured by means of the sensor.

This mode allows activating the following equipment, notably:

1. Fuel feeding screw.

Pressing the  pushbutton causes the activation of the feeding screw connected to the

controller, as well as the illumination of the **bottom** control diode found on the  pushbutton. When the pushbutton is pressed again, the feeding screw is deactivated and the control diode goes off.

2. The fan.



When the  pushbutton is pressed, the fan connected to the controller is activated, and the corresponding top control diode goes on. When the pushbutton is pressed again, the fan is deactivated and the control diode goes off.

In this operation mode, the feeding screw and the fan may be activated and deactivated irrespective of one another.

Pressing the  pushbutton causes the controller to abandon the automatic operation mode (heating and sustaining) and to enter the manual operation mode, involving the immediate stop of the operation of the fan, feeding screw and pump.

5.3. Automatic operation

When the  pushbutton is pressed, the controller enters the automatic operation mode.

1. This operation mode is signalled through the **top** control diode going on. The automatic operation in false controlling the coal feeding screw and fan so that the temperature of the water in the boiler is maintained at the level preset by the user.
2. In this operation mode, the controller will additionally show whether the feeding screw and/or fan is activated through the activation of the corresponding control diodes arranged on the  pushbutton.
3. When the automatic operation mode is activated, the controller will start the central heating system circulation pump, if the boiler water temperature is more or equal to the factory set value (d2 servicing parameter). Also the pump operation control diode (the vertical dash on the left hand side of the display) goes on.
4. The controller will stop the pump if the temperature of water drops to the temperature of pump activation minus 4 degrees Centigrade.
5. When the feeding screw stop time set has elapsed, the controller causes the feeding screw to start operation for the preset loading time, after which the feeding screw is deactivated, etc. (the cycle is repeated).
6. The method in which the controller finds out that the furnace has put down:
 - if, in the automatic mode of operation, the boiler water temperature reduces by 10 degrees Celsius, the growth by more than 4 degrees Celsius not occurring in the course of temperature value reduction, the pump is deactivated. The controller will store the temperature and wait for the period of time factory set (c3 servicing parameter), after which will check whether the temperature has risen. If not, this means that the furnace has put down;
 - if the controller enters the automatic operation mode in the course of the thermostat interlock, the procedure of checking whether the furnace has put down is not activated.
7. The display will show the temperature of water measured. When the  pushbutton is pressed, all the equipment is deactivated and the manual operation mode resumed.

8. When the  pushbutton is pressed, the controller enters the programming mode which does not affect the automatic operation mode.

5.4. Sustaining mode operation

When this mode is activated, the display shows the boiler water temperature measured, as well as the bottom control diode on the  pushbutton, signalling the sustaining operation mode, is on. The pump is on if the temperature is more or equal to the factory set value (d2 servicing parameter).

Following entering the sustaining mode, the fan will remain activated for the c2 time, multiplied by c4 multiplication factor so that the fuel added can start burning, following which the fan will be deactivated. After the sustaining time has elapsed (u3 user parameter), the controller will start the feeding screw and the fan for the factory set time (c2 servicing parameter), in spite of the thermostat operation. The fan will operate correspondingly longer (u4 parameter) than the feeding screw so that the added fuel can start burning.

If the temperature drops to the value that is equal to the value preset by the user minus d3 servicing parameter, the controller will resumed the automatic operation mode.

When the  pushbutton is pressed, the programming mode is entered, similarly to the automatic operation mode.

When the  pushbutton is pressed, all the equipment is deactivated and the manual control operation mode is resumed.

5.5. Alarm modes

Five alarm modes are recognized by the controller. Except for AL4, the number of alarm will be shown, as well as the acoustic alarm output will be activated for the period of two seconds. Then this output will be deactivated for the period of two seconds, to be activated again, etc..





Except for the AL4, the abandonment of the alarm modes is possible only when the  pushbutton is pressed.

Kinds of alarms:

- AL1 → Damage to the boiler outlet water temperature sensor;
- AL2 → Damage to the feeding screw temperature sensor;
- AL3 → Failure of the return temperature sensor or DHW temperature sensor or breaking the feeder roller (reed relay failure)
- AL4 → The outlet water has reached the temperature exceeding 95 degrees Centigrade;
- AL5 → The furnace has put down;
- AL6 → The maximum temperature in the feeding screw has been exceeded or the feeding screw temperature sensor has broken down.

Where the AL4 alarm has occurred, the temperature measured and the alarm message (AL4 text) is displayed alternately. If the controller detected the alarm in the course of manual operation mode, the central heating system circulation pump will be activated. This alarm will automatically go off when the temperature in the boiler drops below 95 degrees Centigrade.

6. USER PARAMETERS CONFIGURATION



When the  pushbutton is pressed, the controller will enter the programming mode which will be signalled by the activation of the control diode on the  pushbutton. The programming does not affect the current operation of the controller. While in the programming mode, the controller cannot change between the manual and automatic operation modes (the controller does not response to pressing the  and  pushbuttons).

6.1. The preset temperature of the boiler outlet water

The following procedure allows to change the preset $\{T^{zad}\}$ temperature of the boiler outlet water:

1. Press the  pushbutton.

The illumination of the diode on the pushbutton signals commencing the temperature setting. The display shows the temperature set to date.





2. Set the desired temperature by means of the  pushbutton (down) and  (up).

The allowable range of changes is programmed by the boiler manufacturer. When this level of temperature is reached, the controller will enter from the automatic operation mode to the sustaining mode.

3. Press the  pushbutton again so that the new level of temperature is stored.



At the same time, the controller will enter the programming mode of the subsequent u1 parameter.

Comments:

- if the  pushbutton is not pressed again, the changes will be discarded;
- if, in the course of setting the new temperature, any of the , , , is not pressed for the period of 20 seconds, the new temperature will not be stored and the controller will abandon the programming mode.

6.2. Time of feeding the coal to the boiler (u1)

This parameter shows the time for which the feeding screw will be activated in the automatic operation mode. The value of these parameters may be modified in the same way as is the case for the u0 parameter.

1. Press the  pushbutton. The controller will display the u0 parameter value.
2. Press the  pushbutton again. The controller will store of the value of the u0 parameter and will switch to u1.

3. Set of the desired value by means of the  pushbutton (down) and  (up).

The allowable range of changes of the parameter is between 5 seconds and 250 seconds.

4. Press the  pushbutton again so that the new value is stored.

At the same time the controller will switch to programming the subsequent u2 parameter.

6.3. Time of stopping the feeding screw (u2)

This parameter shows the time between the subsequent supplies of the coal to the boiler in the automatic operation mode. The range of changes is between 5 seconds and 250 seconds. The parameter in question may be modified in the same way as shown in item 6.1 and 6.2.

6.4. Sustaining time (u3)

This parameter will show the time after elapsing of which the controller will activated the feeding screw and fan for the factory preset time (c2 servicing parameter), in the sustaining time, so as to present the furnace from putting down. The range of changes is between 5 minutes and 250 minutes. The parameter in question may be modified in the same way as shown in item 6.1 and 6.2.

6.5. Delay in fan deactivation under sustaining mode (u4)

This delay is aimed at allowing the added fuel to burn in the sustaining mode. The range of changes is between 5 seconds and 250 seconds. The parameter in question may be modified in the same way as shown in item 6.1 and 6.2.





The subsequent pressing of the  pushbutton will cause the return to the mode from which the programming mode was called for, as well as the deactivation of the programming control diode.



7. CONFIGURATION OF THE SERVICE PARAMETERS

In order to modify the service parameters proceed as follows:

1. Turn off the controller using button .

Four horizontal bars will appear on the display.

2. Simultaneously press three buttons: ,  and  and hold them for about 3 seconds. The controller will go into the programming mode, indicated by lighting up of the indicator on button  and the value of the first service parameter C0 will be displayed.

3. Set the desired value of the parameter using buttons  (down),  (up).

4. Press again  and the new value of the parameter will be saved.

At the same time the controller will go into programming of the next parameter C2, etc.

5. After programming the parameter D4 press again button .

The controller will return to the off state, and the programming indicator on button

 will go off.

6. Turn on the controller using button .

The controller will start to work with the newly saved settings of the service parameters.

Pressing button  at any time returns the controller to its off state without saving the modified parameter in the memory, and the programming indicator will go off.

Remarks on SBR programming:

1. IT IS THE RESPONSIBILITY OF THE MANUFACTURER TO ENTER NEW SETTINGS REQUIRED FOR NORMAL FUNCTIONING OF THE BOILER!!!
2. Do the programming carefully, preferably writing down earlier the values of the particular parameters on a sheet of paper. Remember that making any error can cause faulty operation, or prevent the boiler from functioning.
3. Having programmed and started the unit check it for proper operation and that the settings of the system parameters are correct.

Temperature hysteresis:

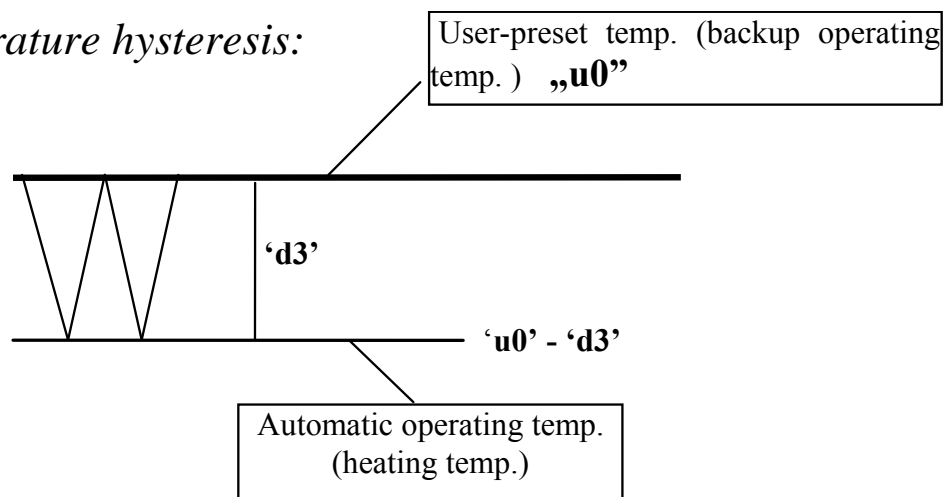

Time of the full rotation of the feeder „c0” must be measured in the manual operation mode – it can be used, after connecting the reed relay on the roller feeder, to detect breaking of the cotter pin of the screw feeder via alarm AL3.

Tabela 1. Service parameter designations and modification limits.

Parameter	Parameter description	Min	Max	Step	Factory preset
C0	Time of fuel feeder rotation (for 0 reed relay being not connected and no alarm for feeder roller breaking)	0	99	1s	0s
C1	On/off parameter for fuel ignition sensor control in the feeder (1- installed sensor, 0- no sensor)	0	1	1	1
C2	Time for starting the feeder and the fan by the controller, when the user-preset backup waiting time is out	5	240	1s	5s
C3	Waiting time for water temperature increase, when the controller checks, if the boiler furnace has gone out, if 'c3'=0 then detection of boiler furnace burnout and AL5 alarm are disabled.	0	250	1min	20min
C4	Coefficient by which the time of fan operation will be multiplied just after the controller goes into the backup state (to make the fuel light up)	1	5	1	1
C5	Time after which the pump will start for 30 secs when interlock by room thermostat is on. If 'c5' =0 the pump will not start.	0	99	1min	0min
C6	Mixing pump control 0 – no pump – relay to alarm 1 – pump on the boiler – mixing pump 2 – pump to boiler – DHW heating	0	2	1	0
D0	Min. temperature to be set by the client	40	60	1°C	40°C
D1	Max. temperature to be set by the client	61	85	1°C	85°C
D2	Pump start temperature	25	80	1°C	40°C
D3	Lower temperature hysteresis	1	10	1°C	2°C
D4	Mixing pump start temperature (when c6=1) or stabilized temperature in the boiler (when c6=2) when the pump is connected	35	60	1°C	40°C

8. MIXING PUMP HANDLING

The controller has been augmented with the option of the realization of the boiler minimal temperature through the operation of the mixing pump connected to the alarm output (see figure 2).

In order to set up the controller for operation with the mixing pump, in the maintenance mode (see: sec.7) you must set the value of the corresponding parameters, i.e.:

1. Value of the parameter c0='0'
2. Value of the parameter c6='1'
3. Set the value of the parameter 'd4' within 35°C -55°C.

The pump will start, when recovery water temperature drops to values preset under parameter '**d4**', and will stop after reaching 50°C. If the value '**d4**' is greater than 49°C the mixing pump will be working, when the inlet water temperature is below 50°C. The pump operation is indicated by a horizontal bar at the bottom panel on the left side of the display.

9. UTILITY HOT WATER VESSEL HANDLING

The G-403-P02 controller allows the connection of the additional pump controlling heating the hot water in the vessel.

9.1. Assembly and connection

If the heating of the utility hot water is required, the following procedure should be adhered to, notably:

1. Connect the boiler in accordance with the diagram shown in figure 1.
2. Place the utility hot water temperature sensor (*) inside the vessel.
3. The assembly of the utility hot water temperature sensor in the measuring wells manufactured by GECO is recommended. The location of the temperature sensors in wells with oil or other liquid is inadmissible.
4. Connect the **utility hot water temperature sensor** (**) to the controller terminals as shown in figure 2.
5. Set the G-403-P02 controller appropriate parameters (see item 8.2).

Legend:

1. Residual valve.
2. Ball cut-off valve.
3. Check valve.
4. Circulating pump.
- 4a. Utility hot water vessel supplying pump.
5. Reticular filter.
6. Boiler fan.
7. Vessel safety tank.
8. Utility hot water temperature sensor of the G-403-P02 controller.
9. Boiler hot water temperature sensor of the G-403-P02 controller.
10. Vessel electric heater.
11. Vessel electric heater temperature sensor.

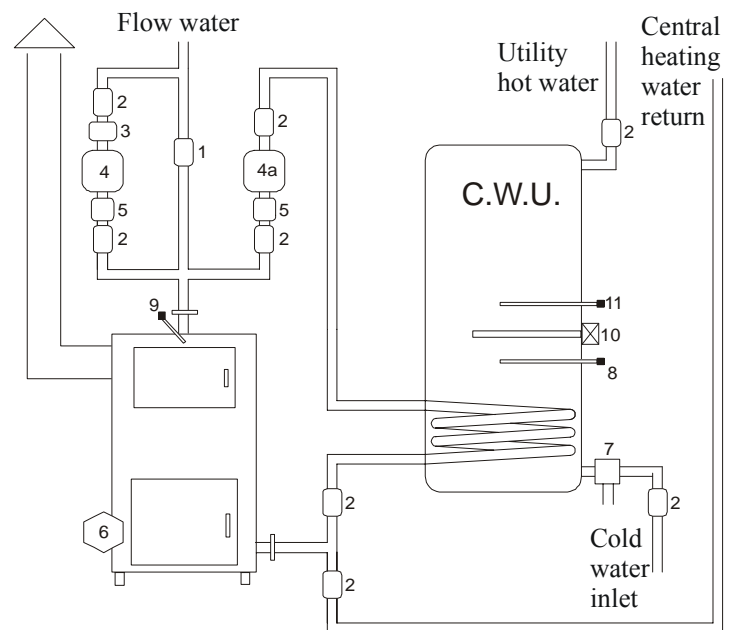

Figure 1. Central heating system block diagram (one circulating pump and one utility hot water vessel replenishing pump).

Comments:

(*) Utility hot water temperature sensor is the additional sensor (option), not supplied together with the G-403-P02. The sensor in question may also be purchased against the additional payment from the manufacturer, i.e. GECO.

(**)Sensors cables may be shortened or extended in any arbitrary way, subject to the following rules:

- the sensor cable should not be trimmed at the distance < 0.5 m away from the shell;
- the extension of the cable above 10 m is not recommended;
- the conductor, type OMY 2x0.5 mm, is recommended for extension purposes;
- the cables should be joined very carefully, each pair of wires being soldered separately and protected by means of the thermal-compressed jacket. Then, the waterproof silicon should be applied to the joints so made, following which yet another thermal-compressed jacket should be applied onto the waterproof silicon.

9.2. Configuration of the parameters

To set up the controller for operation with the auxiliary DHW pump, in the maintenance mode (see: sec.7) set the value of the corresponding parameters, i.e.:

1. Value of the parameter **c0='0'**
2. Value of the parameter **c6='2'**
3. Set the boiler preset temperature (value of the parameter) **'d4' within 35°C -60°C.**

NOTE !!!

To ensure proper operation of the DHW pump and the room thermostat set the boiler preset temperature (parameter U₀) to be minimum 3⁰C higher than DHW boiler temperature. (service parameter D4).

When the boiler temp. is greater than or equal to the current temperature of the boiler, the DHW pump will not operate in order not to cool down the boiler, while the boiler preset temperature can now be reached (it will be lower than the temp. in the boiler).

In this case the controller will not go into interlock status caused by operation of the room thermostat and DHW pump will remain shut down.

10. ROOM PANEL

The controller supports the room panel of our manufacture. The controller responses to the panel orders if the controller is under the automatic operation mode. Where the malfunction occurs to the connection with the panel, the controller will resume the operation with the user programmed settings.

The illuminated dot on the segment on the left-hand side of the display shows that the communication link is operable.

11. METHOD OF CONNECTING THE EQUIPMENT TO THE G-403-P02 CONTROLLER

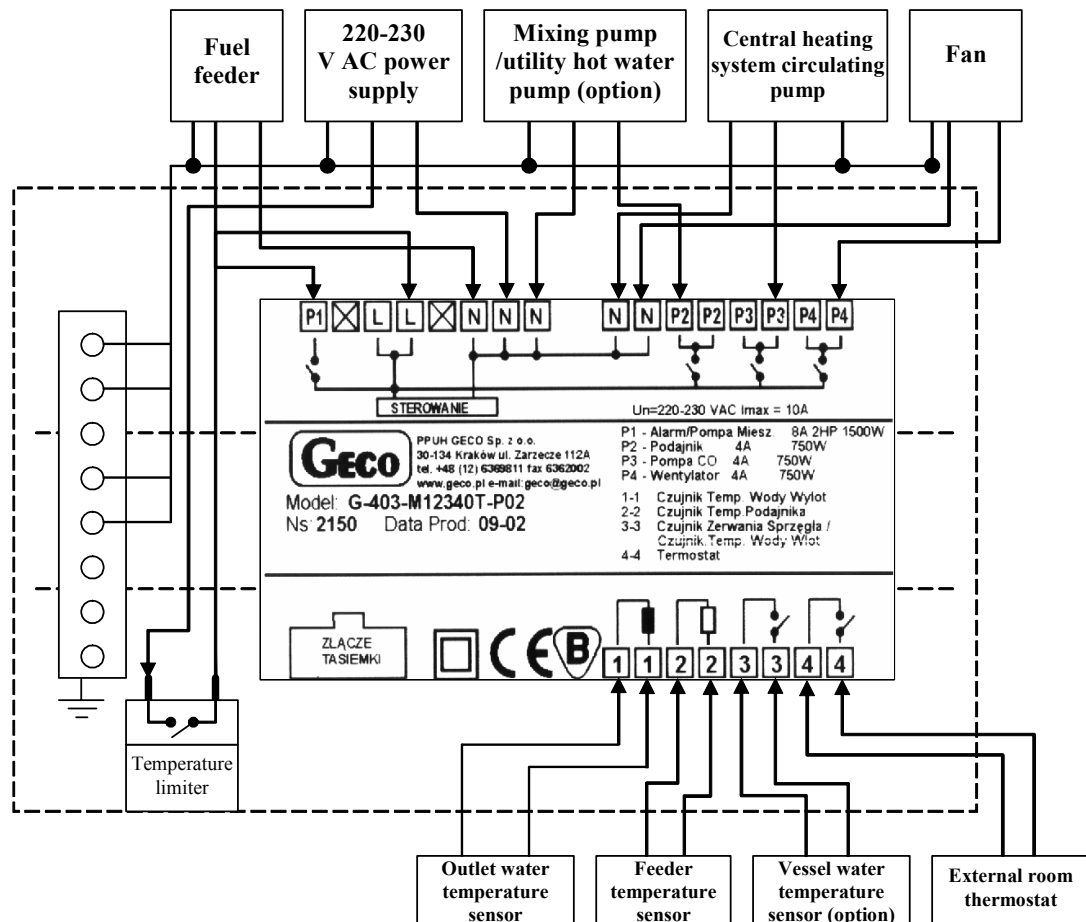

Figure 2. Diagram of equipment connection to the G-403-P02 controller

Important:

The additional equipment to the G-403-P02 controller may be connected only by the person holding the certificate for performing electrical assembly works.

NOTE



In the G-403-P02 controller starting from v.11 the points of wiring from the fuel feeder and DHW pump have been switched over.

/See: fig. 2 page 15/

Please consult the information mentioned above and pay special attention when connecting the fuel feeder.

12. TROUBLESHOOTING GUIDE

Symptoms	Remedy methods
1. The display remains dim, but the controller is connected to the mains.	Check: <ul style="list-style-type: none"> • whether the 230 V voltage is present on the terminals L and N • the correctness of the connection of the actuating module with the control panel • remove and apply again the data transfer tape sockets • connect another data transfer tape
2. The feeding screw does not start in spite of the fact that its activation it signalled by the green diode.	Check: <ul style="list-style-type: none"> • whether the 230V voltage is present on the terminals in accordance with the description provided on the upper wall of the actuating module • feeding screw operability • the correctness of the connection of the actuating module with the control panel • connect another data transfer tape
3. The fan does not start in spite of the fact that its activation it signalled by the green diode.	Check: <ul style="list-style-type: none"> • whether the 230V voltage is present on the terminals in accordance with the description provided on the upper wall of the actuating module • fan operability • the correctness of the connection of the actuating module with the control panel • connect another data transfer tape
4. The pump does not start in spite of the fact that its activation it signalled by the red diode.	Check: <ul style="list-style-type: none"> • whether the 230V voltage is present on the terminals in accordance with the description provided on the upper wall of the actuating module • pump operability • the correctness of the connection of the actuating module with the control panel • connect another data transfer tape
5. Erroneous temperature indications	Check: <ul style="list-style-type: none"> • the connection of the sensors to the connector • the correctness of the sensor fastening • sensor cable condition; no damages to the cable are allowed • carefully the appearance of the external surface of the sensor shell, i.e. check for mechanical injuries • connect another data transfer tape
6. Controller "abnormal" or "strange" operation	Check: <ul style="list-style-type: none"> • whether the 230 V voltage is present on the terminals L and N • the condition of feeding connectors • the condition of wiring system and the number of equipment connected to one phase • whether the control panel, actuating module or tapes plugs have not been exposed to water or other liquid • whether the control panel, actuating module or tapes plugs are not exposed to moisture or sudden temperature fluctuations • the correctness of the connection of the actuating module with the control panel • connect another data transfer tape
7. Display is blinking, and cannot be turned on	Check <ul style="list-style-type: none"> • the value of the power supply voltage • condition of the feeding connectors • the condition of feeding connectors screwing in • the correctness of the connection of the actuating module with the control panel • connect another data transfer tape.



PRZEDSIĘBIORSTWO
PRODUKCYJNO-USŁUGOWO-HANDLOWE
Spółka z o. o.

ul. Zarzecze 112 A, 30-134 KRAKÓW POLAND
tel. +48(12)6369811, 6361290
fax. +48(12)6362002
e-mail: geco@geco.pl
http://www.geco.pl

Complaint card 1
for temperature controller
type G-403-P02

I. CONTROLLER DATA:

Controller type:

Manufacturing date:

Module serial number:

Panel serial number:

II. BOILER DATA:

Boiler manufacturer:

Boiler type and power:



PRZEDSIĘBIORSTWO
PRODUKCYJNO-USŁUGOWO-HANDLOWE
Spółka z o. o.

ul. Zarzecze 112 A, 30-134 KRAKÓW POLAND
tel. +48(12)6369811, 6361290
fax. +48(12)6362002
e-mail: geco@geco.pl
http://www.geco.pl

Complaint card 2
for temperature controller
type G-403-P02

I. CONTROLLER DATA:

Controller type:

Manufacturing date:

Module serial number:

Panel serial number:

II. BOILER DATA:

Boiler manufacturer:

Boiler type and power:

CERTIFICATE



The Certification Body
of TÜV Management Service GmbH

certifies that

PPUH
"GECO" sp. z o.o.
PL-30-134 Kraków, ul. Zarzecze 112 A

has established
and applies a Quality System for

**design, production, sales and service of
electronic measurement and control devices
for industrial automation and home appliances.**

An Audit was performed, Report No. **70001206**
Proof has been furnished that the requirements according to

DIN EN ISO 9001:2000

are fulfilled. The certificate is valid until **April 2004**

Certificate Registration No. **701002871**

Mannheim, June 11, 2002

Certification Body
of TÜV Management Service GmbH
Unternehmensgruppe TÜV Süddeutschland



CERTIFICATE ◆ CERTIFICADO ◆ CERTIFICAT ◆ 認証証書 ◆ CERTIFICATE ◆ CERTIFIKAT ◆ ZERTIFIKAT

MS01/2.99



P.P.U.H. „Geco” spółka z o. o.
ul. Zarzecze 112 A
30-134 Kraków POLAND
tel. 012 6369811, 6361290
fax. 012 6362002